

6-FM-50Ah

Valve-regulated Lead Acid Battery Specification

Features

- Maintenance free
- Safety and no leakage
- Excellent recharge and discharge performance
- Low self-discharge rate
- Adapt to high or low temperature
- Good deep discharge performance
- Longer cycle life



Specification

Rated Voltage	12V
Numbers of cells	6 Cells
Capacity	50Ah@10hr-rate to 1.80V per cell @25°C
Weight	16.3kg
Internal Resistance	Approx. 7 mΩ
Terminal	F6
Max. Discharge Current	750A(5s)
Short Circuit Current	2500A
Max. Charging Current	12.5A
Reference Capacity	C10 50.0AH C3 46.0AH C1 33.1AH
Design Life	10~15 years
Float Charging Voltage	13.6 V~13.8 V @ 25°C Temperature Compensation: -20mV/°C/Cell
Cycle Use Voltage	14.4 V~14.9 V @ 25°C Temperature Compensation: -30mV/°C/Cell
Operating Temperature Range	Discharge: -15°C~50°C Charge: 0°C~40°C Storage: -15°C~40°C
Normal Operating Temperature Range	25°C±5°C
Self Discharge	Less than 3% at 25°C per month
Container Material	A.B.S. UL94-HB, UL94-V0 Optional.

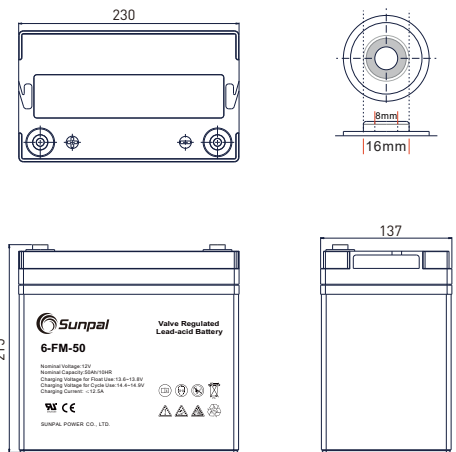

Length	230±2mm (9.1 inches)
Width	137±1mm (5.4 inches)
Height	210±1mm (8.3 inches)
Total Height	215±1mm (8.5 inches)

Constant Current Discharge Characteristics: A(25°C)

F.V/Time	5min	10min	15min	20min	30min	45min	1h	3h	5h	10h	20h
1.80V/cell	112.25	89.35	76.36	54.87	42.98	33.60	15.60	12.55	8.93	6.00	3.22
1.75V/cell	123.38	97.53	82.15	56.95	44.51	35.13	15.93	12.87	9.19	6.07	3.25
1.70V/cell	134.40	104.18	86.29	59.24	46.36	36.22	16.36	13.20	9.37	6.12	3.31
1.65V/cell	145.09	110.73	91.75	62.51	47.45	37.42	17.02	13.64	9.58	6.25	3.35
1.60V/cell	157.53	118.47	97.64	66.00	49.53	38.73	17.56	14.07	9.79	6.32	3.37

Constant Power Discharge Characteristics: WPC(25°C)

F.V/Time	5min	10min	15min	20min	30min	45min	1h	3h	5h	10h	20h
1.80V/cell	206.62	165.82	143.35	104.07	82.36	64.80	30.33	24.44	17.56	11.89	6.43
1.75V/cell	224.29	179.45	152.84	107.56	85.09	67.53	30.87	24.98	18.00	12.00	6.48
1.70V/cell	240.98	190.15	159.71	111.49	88.25	69.49	31.64	25.53	18.44	12.11	6.59
1.65V/cell	258.22	200.95	168.87	117.05	90.11	71.56	32.84	26.40	18.76	12.33	6.67
1.60V/cell	275.56	212.29	178.04	122.40	93.05	73.53	33.71	27.05	19.09	12.44	6.70

6-FM-50Ah

Valve-regulated Lead Acid Battery Specification

Charge Characteristics for Float Use @ 25°C/77°F

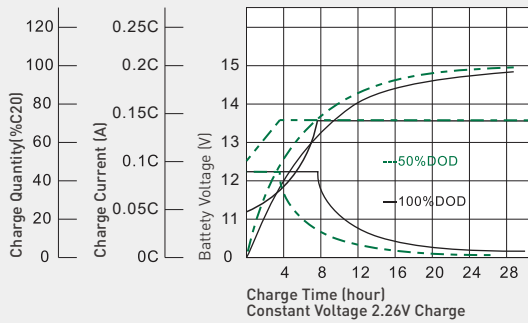

Discharge Characteristics at Various Rates @ 25°C/77°F

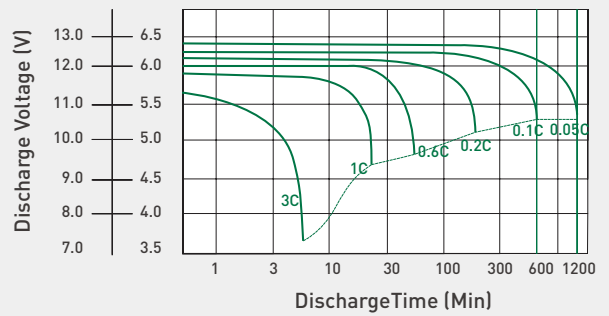

Cycle Life in Relation to Depth of Discharge

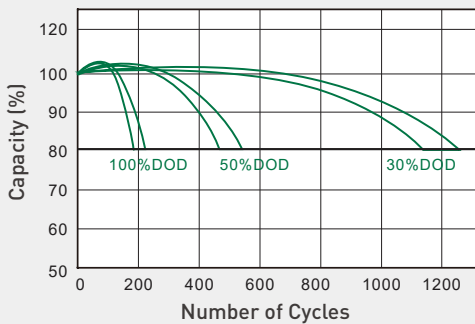

Float Service Life

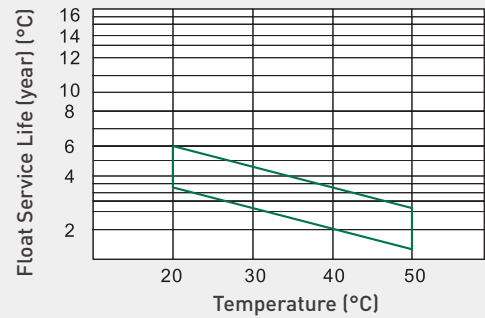

Temperature and Valid Capacity

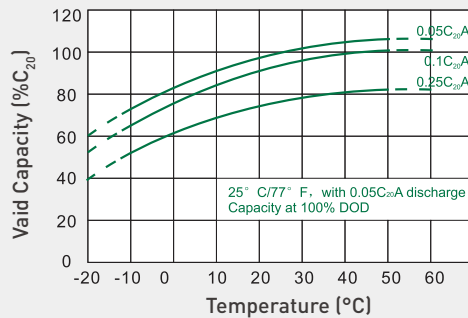

Self Discharge Characteristics

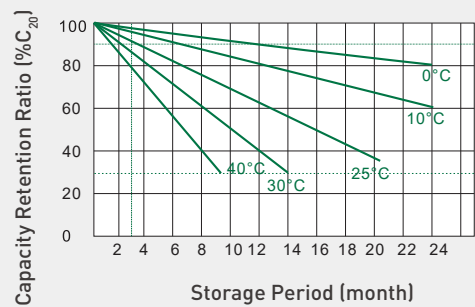

Capacity and Open Circuit Voltage

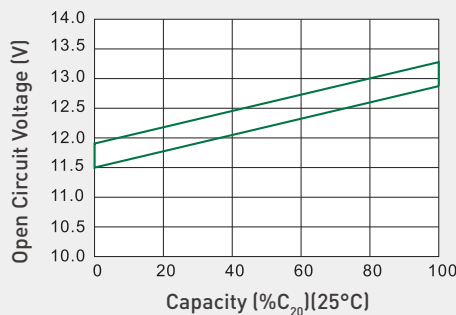

Relationship between Charging Voltage and Temperature

